

Amberly Warner

MATH H324

April 17, 2011

Hyperbolic Geometry and its Many Models

Unlike Euclid's geometry, non-Euclidean geometry is a relatively new idea that was not discovered until the eighteenth century, and its discovery is not without controversy. Janos Bolyai, who read the first six books of Euclid's *Elements* by age twelve, privately worked on the topic inspired by his father's work in proving the fifth postulate. Originally, Farkas Bolyai tried to convince his son to stop his research saying, "...it may take all your time, and deprive you of your health, peace of mind, and happiness in life."¹ Bolyai's father was great friends with the most prominent mathematician of the time, Friedrich Gauss. Trusting his friend, Farkas sent his son's work to him. Unfortunately, Gauss wrote back and claimed that he had already discovered all of Bolyai's results, but was simply waiting to publish them. Crushed, Janos Bolyai fell into a deep depression and never went any farther or published any more of his work in non-Euclidean geometry. There is some evidence that Gauss had actually been working on similar results to Bolyai's, but he was too afraid to publish them. He feared the contempt of the metaphysicians and, as a perfectionist, he did not want to publish incomplete results. The third player in the discovery of this new kind of geometry was Nikolai Ivanovich Lobachevsky. He was a Russian who was the first to write a formal publication regarding non-Euclidean geometry in 1829. Just as Gauss had feared, he received much criticism. However, he had the drive to continue publishing. Eventually, Gauss conceded that "Lobachevsky carried out the task in a masterly

¹ Carl B. Boyer, *A History of Mathematics*, revised by Uta C. Merzbach (New York: John Wiley and Sons, Inc., 1991), 521.

fashion and in a truly geometric spirit.”² In retrospect, the work of Boylai and Lobachevsky was strikingly similar. Although these were the three major players in bringing ideas about non-Euclidean geometry to the forefront, Beltrami, Klein, Poincaré, and Riemann all helped to develop the subject.³ Even though it comes with a dramatic history, non-Euclidean geometry, particularly hyperbolic geometry, is an often abstract subject that requires accurate visual representations to gain a concrete understanding.

Before investigating different ways to represent the hyperbolic plane, it is important to gain a general understanding of what hyperbolic geometry is. By definition, it is the geometry you get by assuming all the axioms for neutral geometry and replacing Hilbert’s parallel postulate by its negation, which we shall call the “hyperbolic axiom.”⁴ The hyperbolic axiom states, “*There exists a line ℓ and a point P not on ℓ such that at least two distinct lines parallel to ℓ pass through P .*”⁵ This axiom is basically just negating Euclid’s fifth postulate and stating that there can be more than one parallel line to another drawn through a single point. There are many important consequences that follow from this particular axiom. The first of which is that all triangles have angle sum less than 180° . Therefore, all convex quadrilaterals must have an angle sum less than 360° . This easily follows as any convex quadrilateral can be divided into two triangles. Additionally, there are no rectangles as there are no right angled triangles. Using this, the universal hyperbolic theorem states:

² Marvin Jay Greenberg, *Euclidean and Non-Euclidean Geometries* (New York: W.H. Freeman and Company, 1993), 184.

³ *Ibid.*, 177-187.

⁴ *Ibid.*, 187.

⁵ George E. Martin, *The Foundations of Geometry and the Non-Euclidean Plane* (New York: Intext Educational Publishers, 1975), 334.

Diagram 1

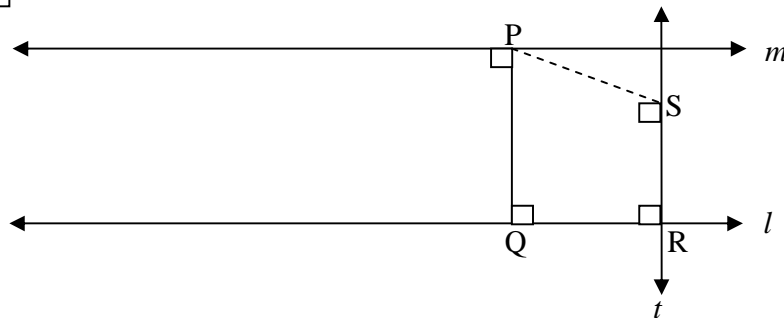

Universal Hyperbolic Theorem: “For every line ℓ and every point P not on ℓ there pass through P at least two distinct parallels to ℓ .”

Proof (reference Diagram 1): Drop perpendicular PQ to ℓ and erect line m through P perpendicular to PQ. Let R be another point on ℓ , erect perpendicular t to ℓ through R, and drop perpendicular PS to t . Now PS is parallel to ℓ , since they are both perpendicular to t . We claim that m and PS are distinct lines. Assume on the contrary that S lies on m . Then PQRS is a rectangle. This cannot be true as it contradicts the lemma denying the existence of rectangles. ■⁶

Another interesting result of this geometry is that it is not possible to have two similar, but non-congruent triangles:

Diagram 2

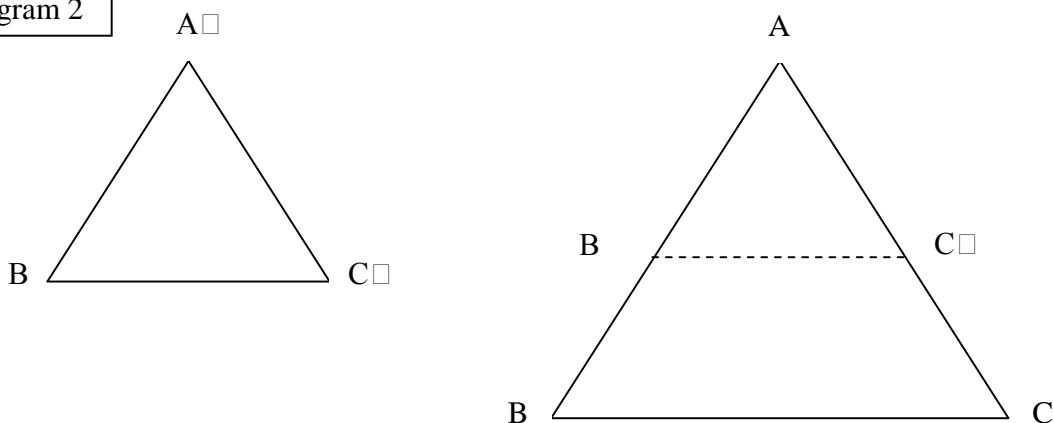

⁶ Greenberg, *Euclidean and Non-Euclidean Geometries*, 188.

Theorem: In hyperbolic geometry, if two triangles are similar, they are congruent.

Proof (reference Diagram 2): Assume on the contrary that there exist triangles $\triangle ABC$ and $\triangle A'B'C'$ which are similar but not congruent. Then no corresponding sides are equal; otherwise the triangles would be congruent. Consider the triples (AB, AC, BC) and $(A'B', A'C', B'C')$ of sides of these triangles. One of these triples must contain at least two segments that are larger than the two corresponding segments of the other triple, e.g. $AB > A'B'$ and $AC > A'C'$. Then, there exists points B'' on AB and C'' on AC such that $AB'' = A'B'$ and $AC'' = A'C'$. By SAS, $\triangle A'B'C' \cong \triangle AB''C''$. Hence, corresponding angles are congruent: $\angle AB''C'' = \angle B'$, $\angle AC''B'' = \angle C'$. By the hypothesis that $\triangle ABC$ and $\triangle A'B'C'$ are similar, we also have $\angle AB''C'' = \angle B$, $\angle AC''B'' = \angle C$. This implies that $BC \parallel B''C''$, so that quadrilateral $BB''C''C$ is convex. Also, $\angle B + \angle BB''C''C = 180^\circ = \angle C + \angle CC''B''$. It follows that quadrilateral $BB''C''C$ has an angle sum of 360° . This contradicts the fact that the sum of the angles of a quadrilateral are less than 360° . ■⁷

It is important to note that although this type of geometry refutes Euclid’s parallel line postulate, the term parallel is still used. Here, parallel refers to non-intersecting lines. What this means to hyperbolic geometry and how to visualize it will be discussed later in reference to specific models of the hyperbolic plane. One final important concept to mention is the angle of parallelism. Referencing Diagram 3, look at line ℓ , a point P outside it and the rays coming out of P and not

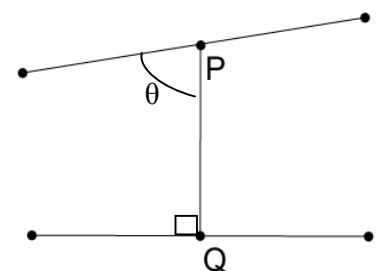

⁷ Greenberg, *Euclidean and Non-Euclidean Geometries*, 190.

intersecting line ℓ . The least value of the angle that a ray parallel to

line ℓ can make with PQ, the perpendicular to ℓ , is called the angle of parallelism Diagram 3 of

parallelism decreases from 90° to 0° as the length of segment PQ increases.⁸ With some of the basic tenets of hyperbolic geometry covered, the next step is to investigate how to create models of the hyperbolic space in order to better visualize the concepts.

Kant said that any geometry other than Euclidean is inconceivable. It is true that hyperbolic geometry is an abstract concept. This was a key issue mathematicians faced in making hyperbolic geometry accepted in the mathematical community. As Lobachevsky said, "There is no branch of mathematics, however abstract, which may not some day be applied to the phenomena of the real world."⁹ It turns out that it is possible to find Euclidean objects that represent hyperbolic objects. In fact, this discovery is what helped to make hyperbolic geometry a recognized form of geometry. The Poincaré, Upper Half Plane, Beltrami-Klein, and Minkowski models all offer different representations of the hyperbolic space from a mathematical perspective. Some of these models are finite, while the others are infinite. The different forms affect how the definition of parallel can be applied. These types of models are useful as they can be manipulated and used for calculations. However, due to the abstract nature of hyperbolic geometry, physical constructions are often more effective in demonstrating key concepts related to hyperbolic geometry. Both types of models are effective and useful in understanding geometry that abandons the familiar Euclidean perspective.

Henri Poincaré was one of the most prominent mathematicians of the twentieth century and he was able to develop a popular model of hyperbolic geometry. In this model, the space consists of all the points in the interior of a circle, although the circle itself is not part of the

⁸ Marta Sved, *Journey into Geometries* (Washington, DC: Mathematical Association of America, 1991), 72.

⁹ Boyer, *A History of Mathematics*, 533.

space. There are different types of hyperbolic lines, which are represented by Euclidean arcs that intersect the boundary of the circle perpendicularly. The first type consists of all line segments along the diameters of the circle with the endpoints of these segments excluded (for example, line ℓ , in Diagram

4). These may appear as straight lines, but can be thought of as the arc of a circle with infinite radius. The second type consists of circular arcs, again ignoring the endpoints of these arcs (for example, lines m and n , in Diagram 4). With an understanding of what a line is, it is

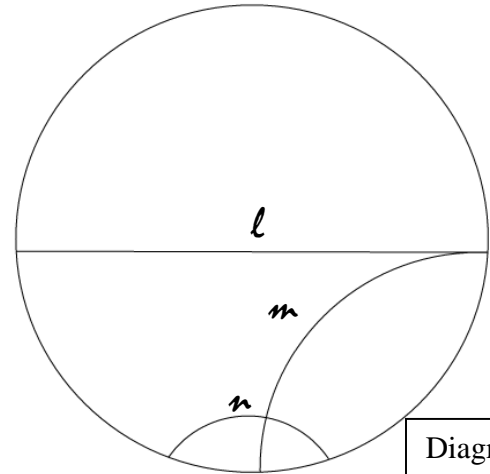

Diagram 4

important to re-visit the definition of parallel in hyperbolic geometry. In this case, there are two different types of parallel lines, asymptotically and divergently parallel. Two lines that have no common points within the model are said to be asymptotically parallel if they intersect on the boundary (e.g. ℓ and m in Diagram 4). Two lines in a model of hyperbolic geometry are

divergently or ultra-parallel if they do not share any common points within the model or on the model's boundary (lines ℓ and n). Additionally, two lines intersect if they share a common point somewhere in the model (lines m and n).¹⁰ Now, looking at Diagram 5

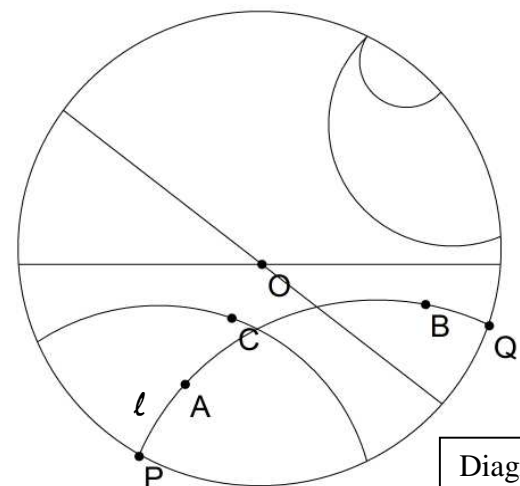

Diagram 5

and with this definition of parallel, one can easily see that Euclid's fifth postulate fails, as both of the lines

through point O would be considered parallel to C because they do not share a common point.

However, the hyperbolic postulate (given any hyperbolic line and a point out of that line, there

¹⁰ Colleen Robles, "The Hyperbolic Geometry Exhibit," last modified July 15, 1996, <http://www.geom.uiuc.edu/~crobles/hyperbolic/hypr/modl/>.

are infinitely many hyperbolic lines passing through that point and parallel to the given point) holds.¹¹ This model may not be Euclidean, but angles are still measured in a Euclidean fashion. Angles are measured by taking the Euclidean measurements of the angles of the tangents to the arcs. For example, to determine the angle of intersection between m and n (in Diagram 4) take the Euclidean tangents to the arcs at the point of intersection and measure the angle with a protractor.¹² Similarly, Euclidean methods are used to determine distance. If you take any two points, A and B, from within the model (see Diagram 5), then there is exactly one hyperbolic line, l , that passes through these points. Now let P and Q be the two intersection points of l with the boundary circle. The hyperbolic distance between A and B can now be defined as $d(A, B) = \ln \frac{d(A,P) \cdot d(B,Q)}{d(A,Q) \cdot d(B,P)}$.¹³ Therefore, if you have two points that are visually a set distance apart from one another and close to the center of the Poincaré model, the hyperbolic distance between these two will increase exponentially as you move them closer to the edge of the model. However, the distance that one can see and observe does not appear to have changed. A final aspect of hyperbolic geometry that is interesting to observe in this model is

triangle congruency. Because hyperbolic length is different from Euclidean length, two triangles can actually be considered congruent without necessarily appearing to be equal.¹⁴ To better understand this fact, it is important to recall that if any two triangles can be proven similar, they are also congruent. Combined with the fact that the

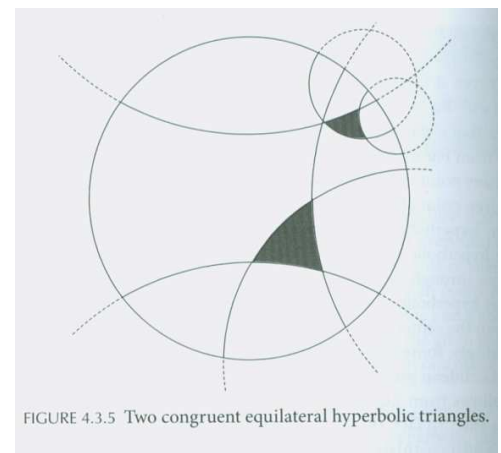

Diagram 6

¹¹ Sasho Kalajdzievski, *Math and Art: An Introduction to Visual Mathematics* (New York: CRC Press, 2008), 156-157.

¹² "The Hyperbolic Geometry Exhibit"

¹³ Kalajdzievski, *Math and Art*, 155.

¹⁴ *Ibid.*, 158.

actual distance between two points is different from what is observable, it becomes easier to see that the two triangles in Diagram 6 are congruent. Although this discussion of the Poincaré model has been brief, while covering a variety of topics, it is necessary to explore other models.

Henri Poincaré also created the upper half plane model. Since the same mathematician developed both this model and the previous one, similarities exist between them. In fact, he created this model first and used it in the development of the disk model.¹⁵ The upper half plane model, as the name suggests, consists of all the points in the upper half of the traditional xy -plane, but excludes those lying on the x -axis. The lines in this model are Euclidean half circles

centered on the x -axis. Vertical lines can be thought of as circles with an infinite radius. The same definitions hold regarding how to determine whether or not lines are parallel. This can best be seen in reference

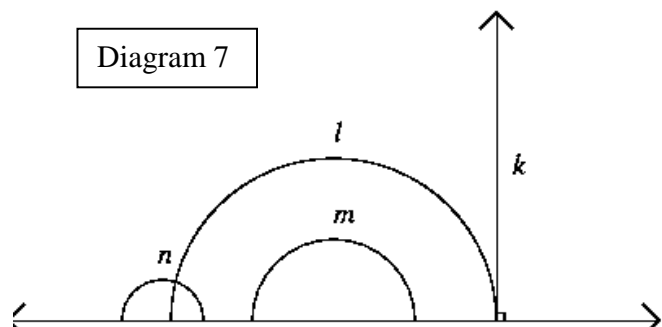

to Diagram 7. Here, lines l and n intersect as they share a common point within the plane. Lines k , m , and n are divergently parallel and lines k and l are asymptotically parallel. As before, this model maintains angle measurements, although it distorts distances. Thus, angles are measured using the Euclidean angles of the tangents.¹⁶ Due to the numerous similarities to the original Poincaré model, there is not much more to include regarding this model. The majority of calculations remain the same. The only difference between these two models is the change of perspective, as this maps the surface on the xy -plane, while the Poincaré model maps the surface on a circle.

¹⁵ David C. Royster, "Neutral and Non-Euclidean Geometries", last modified October 21, 1996, <http://math.uncc.edu/~droyster/math3181/notes/hyprgeom/node58.html#SECTION00203000000000000000>.

¹⁶ "The Hyperbolic Geometry Exhibit"

The Beltrami-Klein model, commonly referred to as the Klein model, is another model used to represent hyperbolic geometry. Eugenio Beltrami described this model in 1868, and Felix Klein fully developed it in 1871.¹⁷ Once again, all the points in the hyperbolic plane are represented in the interior of a circle where the circle itself is excluded. Any point or line segment falling outside the circle is excluded as well. Hyperbolic lines are represented as open

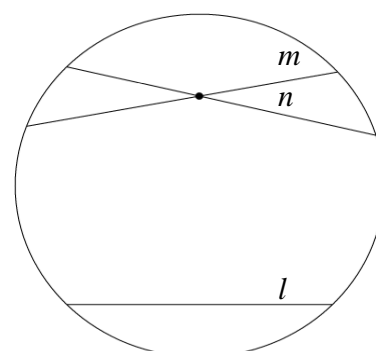

Diagram 8

chords, meaning the endpoints are excluded. Two such lines are considered parallel if they have no points in common with asymptotically and divergently parallel lines maintaining the same definition as in the Poincaré model. As a result, the hyperbolic postulate holds in this model. Referencing Diagram 8 and using the definition of parallel lines, it is obvious that both m and n are parallel to l . Unlike the Poincaré model, it is difficult to measure angles in the Beltrami-Klein model. Angles can only be measured with a protractor at the origin. Using this method with angles falling elsewhere results in incorrect measurements. Consequently, proving triangle congruence is also an issue. However, there exists an isomorphism between the Klein-Beltrami model and the Poincaré model that can be used to simplify this process. To measure angles in the Klein-Beltrami model we can map the two intersecting lines to the Poincaré model using the isomorphism and measure the angles in the Poincaré model using the method previously described.¹⁸ To clarify, isomorphism means that a one-to-one correspondence can be set up between the points and lines in one model with the points and lines in another model. Looking at the number of similarities between the models, it seems obvious that this action would be possible. In fact, all possible models of hyperbolic geometry are isomorphic to one

¹⁷ Daina Taimina, *Crocheting Adventures with Hyperbolic Planes* (Natick, MA: A K Peters, Ltd., 2006), 76-77.

¹⁸ "The Hyperbolic Geometry Exhibit"

another. Diagram 9 depicts an isomorphism between the Klein and Poincaré model. On the Klein model, consider a Euclidean sphere of the same radius sitting on the plane tangent at the origin. Now, project upward

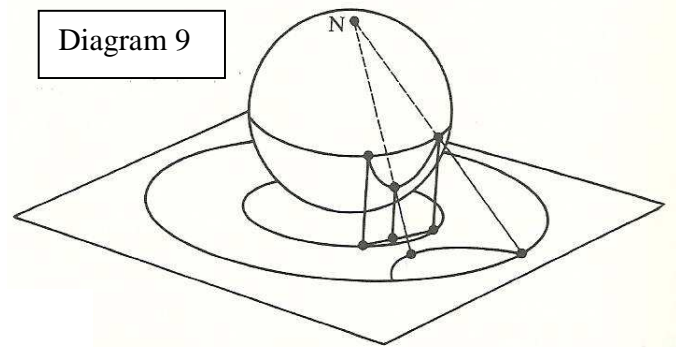

and orthogonally, the entire Klein model onto the lower hemisphere of the sphere, making the chords arcs of circles orthogonal to the equator. Then, project stereographically from the north pole of the sphere onto the original plane. The equator of the sphere will project onto a circle larger than the one used in the Klein model, and the lower hemisphere will project stereographically onto the inside of this circle. Under these successive transformations, the chords of the Klein model will be mapped one-to-one onto the diameters and orthogonal arcs of the Poincaré model.¹⁹ Once on the Poincaré model, calculations can be done as described above for that model. It is important to note that the stereographic projection used in this process is essential as it preserves angles and has the ability to take spheres to planes and planes to spheres.²⁰ While the Klein and Poincaré models both provide accurate representations of the hyperbolic space, there is yet another model to consider that is very different from both of these.

The Minkowski model is unique compared to the previous two and comes from the theory of special relativity. Unlike the others, this model can be multi-dimensional. It is not rooted in Euclidean concepts. As a result, it is more complex. This model needs to be embedded in a space dimension one greater than its own.²¹ Distance is measured using the Minkowski metric, $ds^2 = dx^2 + dy^2 - dt^2$. The surface is a sphere centered at the origin of imaginary radius i

¹⁹ Greenberg, *Euclidean and Non-Euclidean Geometries*, 237-8.

²⁰ James W. Cannon et al., "Hyperbolic Geometry", *Flavors of Geometry* 31 (1997): 14.

²¹ "The Hyperbolic Geometry Exhibit"

$= \sqrt{-1}$. To visualize this surface in Euclidean terms, it is a two-sheeted hyperboloid (see Diagram 10). Points on this model correspond to points on a hyperboloid. Lines are the intersection of the hyperboloid with planes passing through the origin. Lengths and angles refer to the standard definition of lengths and angles in space time. To find the angle between two curves, take the normal vectors to the planes they lie in and the angle is given by the formula: $\cos(\theta) = \frac{\vec{u} \cdot \vec{v}}{|\vec{u}| |\vec{v}|}$. Because this model is closely related to

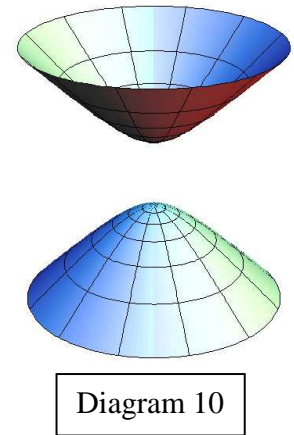

special relativity, many of the associated concepts fall beyond the scope of this paper. However, the brief overview given thus far provides the basic foundations of this model. One additional fact to note is that like the previous model, there is an isomorphism between the Minkowski model and the Beltrami-Klein model. To do so, let the hyperboloid be denoted Σ and the plane $t = 1$ is tangent to Σ at point $C = (0, 0, 1)$. Let the Klein model be denoted Δ and be the unit disk centered at C in this plane. Projection from the origin $(0, 0, 0)$ gives a one-to-one correspondence between the points of Δ and the points of Σ . Similarly, each chord m of Δ lies on a unique plane through O and m corresponds to the section $m \square$ of Σ cut out by the plane.²² As before, using this isomorphism helps to simplify calculations. Also, the fact that these isomorphisms exist between models demonstrates that although there are numerous analytic models, they each provide an accurate depiction of the hyperbolic space.

Models for the hyperbolic plane are useful for visualizing key concepts, verifying proofs, and accompanying theorems. However, physical constructions of hyperbolic planes are tangible and more useful for coming to understand basic tenets of this geometry. By definition, a hyperbolic plane is “a simply connected Riemannian manifold with negative Gaussian

²² Greenberg, *Euclidean and Non-Euclidean Geometries*, 242.

curvature.”²³ It is the geometric opposite of the sphere because it is open and infinite with space curving away from itself. It may seem impossible to create a tangible, physical model to represent such a space. However, examples exist, even in nature, from lettuce leaves to coral to cacti. The key in creating a synthetic model is to create a surface that has a constant negative curvature. As Riemann pointed out, “...hyperbolic geometry would be the intrinsic geometry of a surface with constant negative curvature that extended indefinitely in all directions.”²⁴ Now, one must know how to calculate curvature of a surface. Gauss discovered that the curvature of a shape could be found by making exact measurements along its surface. This could mean starting at a point and measuring the circumference of circles centered on that point with various radii measured on that surface. Positive curvature results when the circumference is less than $2\pi r$, and negative curvature results when the circumference is greater than $2\pi r$. In a hyperbolic plane, the Gaussian curvature is $-1/r^2$ where r denotes the radius of the plane.²⁵ Throughout the more recent years, there have been numerous attempts to create physical models with various degrees of success.

The first such model was made using paper annuli. This model is known as the annular hyperbolic plane. In the 1970s, William Thurston came up with this idea to avoid the use of equations in creating the hyperbolic space.²⁶ For a time, this popular paper and tape model was the sole physical model available. In this method, paper annular strips are attached together with tape to represent the space. An annulus is the region between two concentric circles. Thus, an annular strip is a portion of an annulus cut off by an angle from the center of the circles.²⁷

²³ David Henderson, Marget Wertheim, and Daina Taimina, “Crocheting the Hyperbolic Plane: An Interview with David Henderson and Daina Taimina,” *Cabinet Magazine* 16 (2005).

²⁴ Taimina, *Crocheting Adventures with Hyperbolic Planes*, 15.

²⁵ David Henderson and Daina Taimina, “Crocheting the Hyperbolic Plane,” *Mathematical Intelligencer* 23 (2001): 17-28.

²⁶ Taimina, *Crocheting Adventures with Hyperbolic Planes*, 19.

²⁷ Crocheting the Hyperbolic Plane pg. 133

To construct this model, one needs at least ten of these strips. Attach these strips together with tape by matching the inner circle of one with the outer circle of the other or by placing them end-to-end. The length of the strips does not necessarily matter, but they must have the same inner and outer radius.

The model can be made as big or as small as necessary. As the paper strips are continually added, the model will start to curve as the process involves attaching something with a smaller radius to something with a smaller radius. The surface that

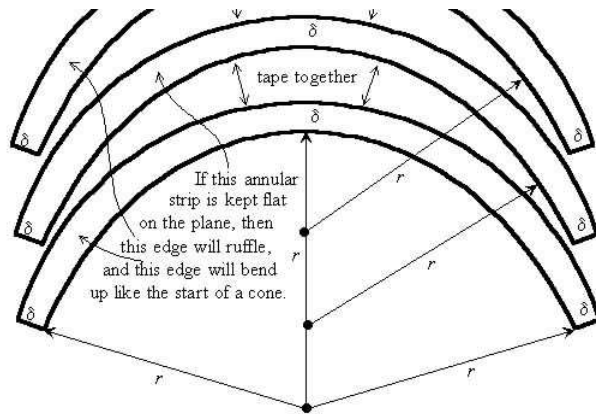

Diagrams 11 and 12

this creates is only an approximation. The actual hyperbolic plane comes from letting $d \rightarrow 0$ and holding the radius fixed, where $d = r_2 - r_1$. Here, r_1 refers to the radius of the smaller circle and r_2 is the radius of the bigger circle.²⁸ Basically, this means that the thickness of the strips themselves would have to become smaller and smaller until they were no thicker than a line.²⁹ Because this surface is constructed the same everywhere, it is known as homogenous. This means that intrinsically and geometrically every point in the model has a neighborhood that is isometric to a neighborhood of any other point. One major drawback to these models is that they are not durable and not easily manipulated. As a result, while this model accurately depicts hyperbolic geometry, the annular hyperbolic plane is not the preferred physical model.

²⁸ "Crocheting the Hyperbolic Plane"

²⁹ Kristin Camenga, "Paper Hyperbolic Plane Models," AMTNYS (2006).

Another method to represent the hyperbolic space is the use of polyhedral constructions. These are made by putting seven equilateral triangles at every vertex. As a result, it is also known as the {3,7} model to describe the three-gons placed seven at a vertex. This model is easier to construct than the annular hyperbolic plane. However, there are still some disadvantages. First, at each vertex the angle is 420° , so it is not possible to achieve better approximations by decreasing the size of the triangles used. The angles will always remain the same. Also, it is difficult to describe coordinates on this model. A modification to avoid some of these issues is to put seven triangles together only at every other vertex and only six triangles together at the remaining vertices.³⁰ There are multiple ways to create this construction. The first is to take polyhedral annuli and tape them together as in the previous model. A polyhedral annulus is seen in Diagram 13. Another method is to construct two annuli at once using a figure as seen in Diagram 14 and tape them together with side $a \rightarrow A$, $b \rightarrow B$, and $c \rightarrow C$. Finally, the preferred method, as it is the quickest, is to start with many strips with any particular length and then add four of the strips together using five additional triangles. The strip is seen in Diagram 15. From here, add another strip at every place there is a vertex with five triangles and a gap.

Looking at Diagram 16, this would be where there are bold black dots. This ensures that at every vertex there are seven triangles. The center of each strip runs perpendicular to each annulus and

Diagrams 13-16

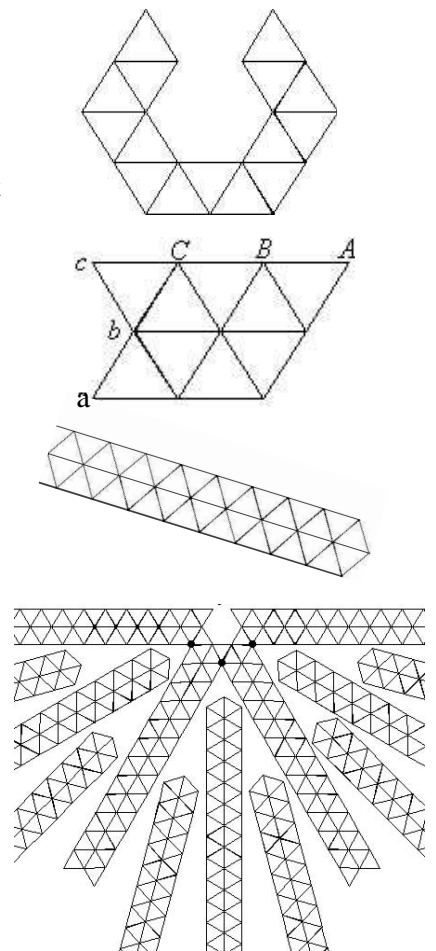

³⁰ “Crocheting the Hyperbolic Plane”

these are geodesics.³¹ To clarify, a geodesic refers to the shortest distance between two points on a mathematically defined surface. On the more familiar Euclidean plane, this would be a straight line.³² This is a good example of the usefulness of physical constructions aiding in concept comprehension, as geodesics are obvious on this model, while they would be more abstract on the analytic models. Although this model is improved from the annular hyperbolic plane model, it still faces the difficulty of not being highly durable and easily manipulated. However, there are possibly variations to this model.

Seven hexagons around a heptagon approximates a hyperbolic plane with a smooth tiling. This model demonstrates negative curvature clearly and is quick to make. It is often called a “hyperbolic soccer ball.” Although, unlike a soccer ball, this model does not close in on a sphere. The polyhedral construction actually curves away from itself because there is more than 360° at each vertex.³³ It is important to note that this model is just an approximation as well because the polygons would need to get smaller and smaller progressively to create an actual hyperbolic plane.³⁴ These types of constructions are useful, but calculations and visualizations still seem abstract. The most original and preferred model is the final one to be discussed.

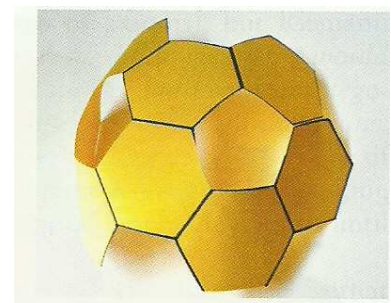
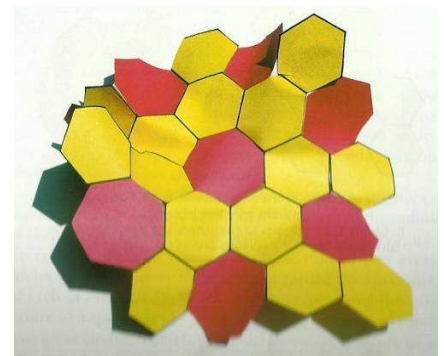

Diagrams 17 and 18

The final, and perhaps the most interesting method for constructing the hyperbolic plane, is the use of crochet. The art of crochet has been around since the fourth century BC when used in ancient Egypt to make fabric. Over the years, it has continued to evolve to become the

³¹ Taimina, *Crocheting Adventures with Hyperbolic Planes*, 134-135.

³² “Geodesic” <http://www.wolframalpha.com/input/?i=geodesic>.

³³ Taimina, *Crocheting Adventures with Hyperbolic Planes*, 14.

³⁴ “Paper Hyperbolic Plane Models”

popular craft that it is today. Crochet has also been used to depict other mathematical surfaces, such as the Riemann surface.³⁵ Not only are these models accurate, but they are also durable and ideal for classroom use. There are a variety of different patterns available to create everything from a basic hyperbolic plane to a pseudosphere. Daina Taimina was the first to crochet a model of the hyperbolic plane in 1997. She actually uses these models in her upper level undergraduate geometry courses to help students understand the concepts of hyperbolic geometry. To make a crocheted hyperbolic plane, all one needs to know is how to make a chain and how to single crochet. The crochet must be tight and even with a constant ratio of increased stitches. The radius of the hyperbolic plane is determined by the ratio of stitches from one row to the next ($N/(N+1)$). The lower this ratio between stitches is, the smaller and more curved the plane will be, reference Diagram 19 for an example.

An infinitely large radius would create a hyperbolic plane reminiscent of the Euclidean plane. Because the larger the ratio, the more stitches are necessary, it is easy to see the concept of exponential growth in this type of model. It can take quite a bit of time to construct a large crocheted hyperbolic plane, while only a matter of minutes to create a smaller version.³⁶ Taimina spent time

experimenting before she was able to develop a method to accurately depict the plane. Because these types of hyperbolic planes are relatively easy to construct and can be various sizes, they are ideal models to explore this type of geometry.

Many different concepts in hyperbolic geometry can be studied on a crocheted hyperbolic plane. Unlike the most popular analytic model, the Poincaré model, which distorts distances



Crocheted hyperbolic plane with ratio 5:6.



Crocheted hyperbolic plane with ratio 3:4.

Diagram 19

³⁵ Taimina, *Crocheting Adventures with Hyperbolic Planes*, 63-67.

³⁶ *Ibid.* 20-23.

while maintaining angles, three-dimensional crochet is able to give a more accurate picture. A model that represents hyperbolic lengths and angles correctly is known as isometric. Asymptotically parallel lines can be seen in the lines that are perpendicular to the rows in the model. These parallel lines diverge away from one another in one direction, but come very close together in the opposite direction. Divergently parallel lines are also perpendicular to the crocheted rows, but these are close together in one place before diverging out in different directions. Contrary to parallel lines, perpendicular lines can be found by first folding the model and then folding again so the first crease lies on itself. This second line will be perpendicular to the first. Another important concept of hyperbolic geometry to explore through crochet is triangle angle measurement. To construct a triangle, pick three points on the model and connect them using straight lines. Note that a straight line in this model is created by folding, without stretching the figure. This clearly demonstrates that the angle sum of the angles in a hyperbolic triangle is less than 180° .³⁷ In fact, the larger the triangle

Diagrams 20 and 21

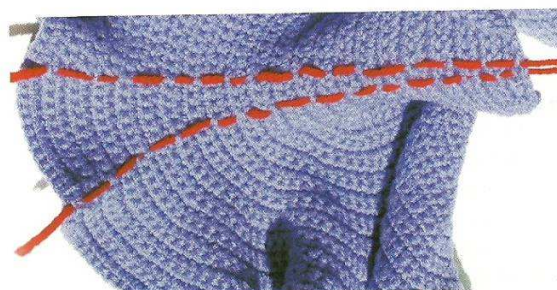

Asymptotic straight lines in the hyperbolic plane: they become closer and closer but never intersect.

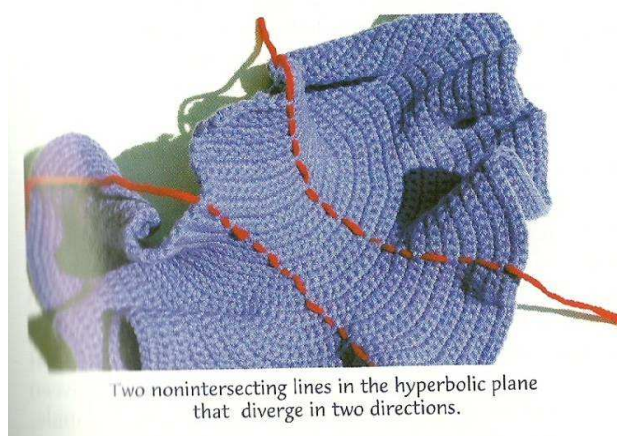

Two nonintersecting lines in the hyperbolic plane that diverge in two directions.



Diagram 22

³⁷ Ibid., 26-31.

one constructs, the closer the angle sum will be to 0° , as seen in Diagram 22. A triangle with an angle sum of 0° is known as an ideal triangle. For comparison, an ideal triangle on the upper half plane model is a triangle with all three vertices either on the x -axis or at infinity.

Furthermore, all ideal triangles on the same plane are congruent. This can be proven using the upper plane model (see Diagram 23) and visualized

in the crochet model. First, perform an inversion that takes one of the vertices on the x -axis to infinity and thus takes the two sides from that vertex to vertical lines. Then apply a similarity to the upper

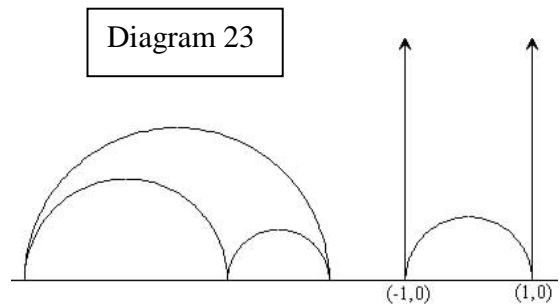

half plane taking this to the standard ideal triangle with vertices $(-1,0)$, $(0,1)$. It is difficult to see how the figure in Diagram 23 is a triangle, yet looking at the crocheted plane, the concept

becomes more visible. Another important fact to note is that the area of an ideal triangle is πr^2 .

Here r represents the radius of the annuli.³⁸ Now, because certain constructions appear

differently on planes of different radii and the radius is necessary to calculate triangle area, it is

important to be able to measure radii on the crocheted plane. To do so, place the crocheted plane on a flat surface and put a thread around the arc that forms to create a full circle. Measure

the diameter of this circle and cut that value in half;

this is the radius of the hyperbolic plane. This procedure

is seen in Diagram 24.³⁹ These are just a few examples of

the concepts that a crocheted hyperbolic plane can depict

as no other model can. Exploration with this accurate

physical model helps to concretize some of the abstract

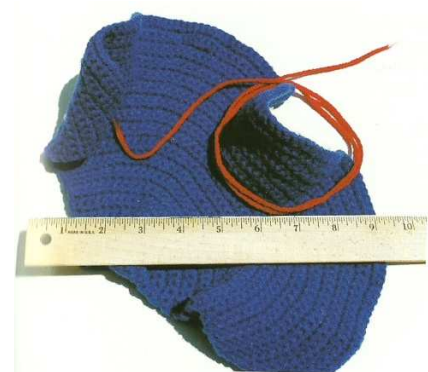

Diagram 24

³⁸ "Crocheting the Hyperbolic Plane"

³⁹ Taimina, *Crocheting Adventures with Hyperbolic Planes*, 30-31.

concepts of hyperbolic geometry.

Although a crocheted hyperbolic plane is a useful learning tool, it is also important to consider whether the plane is symmetric and of constant negative curvature. The following formula is integral to ensure those conditions are met: $C = \pi R \cdot \left(e^{\frac{r}{R}} - e^{-\frac{r}{R}} \right)$. Here, the C represents the intrinsic circumference of a circle with an intrinsic radius r on a hyperbolic plane with a radius R . Intrinsic means that the distance is measured along the surface of the hyperbolic plane.⁴⁰ The intrinsic radius of the n th row is equal to $n \cdot h$, where h is the height of the crocheted stitch. Now, the ratio $C(n)/C(n-1)$ where n is the row number determines how to increase stitches. When crocheting, one should mark where each new row starts in order to be able to maintain the proper ratio. Once there are enough rows, the increase will stay the same as it reaches the limit of the previous formula. These calculations may exist, but it is still critical to consider the type of yarn, desired radius, and the tightness of stitches that you are using when making the model. Individual crochet style will affect calculations. Another feature that can be seen here is that on a hyperbolic plane, the circumference of a circle is larger than the circle with the same intrinsic radius on the plane. To see this more clearly, look at Diagram 25, where there was one hundred meters of yarn for each shade of purple. This one hundred meters was only enough to stitch two rows in the lightest shade at the edge of the hyperbolic plane. If the radius of the intrinsic circle was five meters, the circumference on a hyperbolic plane

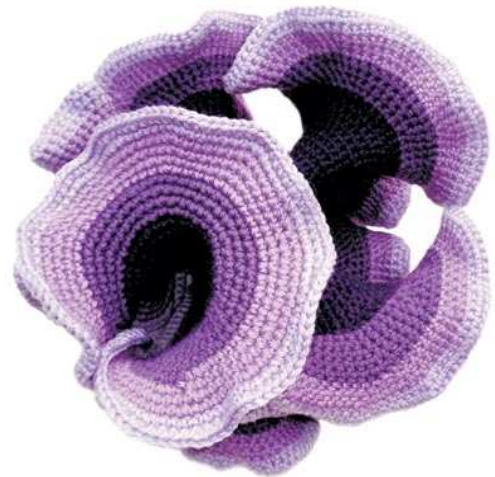

Diagram 25

⁴⁰ Ibid., 83.

would be 49,000,000 kilometers, while on a Euclidean plane, the circumference would only be 31.4 meters.⁴¹ These measurements alone clearly demonstrate the exponential growth seen in this geometry. The ratio of stitches in one row is in direct proportion to the ratio of stitches in the next row. Depending on the ratio used, the crocheted hyperbolic plane can grow extremely fast, just as the actual hyperbolic plane extends to infinity. Although time consuming, creating an accurate hyperbolic plane through the use of crochet can be a worthwhile learning experience that continues to be useful even after its completion.

Hyperbolic geometry is an abstract concept. It differs from the well known and widely accepted Euclidean geometry. However, it has numerous real world applications. In biology, hyperbolic geometry is used to study the brain. In computer science, it can be used to solve NP problems. In chemistry, it is used in research in the structure of molecules. In medicine, it is used to find ways to perform reconstructive surgery and in analyzing brain images. In physics, it is used in ergodic theory and in string theory. In network security, it is used to construct graphs. In music, it is used to understand musical chords. In art, it is used in modern paintings, sculpture, and CAD technology.⁴² In fact, scientists hypothesize that the shape our universe could be a three dimensional version of the hyperbolic plane.⁴³ With so many people in so many different areas using hyperbolic geometry it is important to have models available to help with general understanding, performing calculations, and manipulating objects in the plane. Whether using the Upper Half Plane model or a crocheted hyperbolic plane, the fact is that the person will benefit from the visual aid. Hyperbolic geometry is a relatively new field, but as its popularity continues to grow, it becomes crucial to develop accurate and easy-to-use models that take the abstract concept and make it more familiar and concrete.

⁴¹ Taimina, *Crocheting Adventures with Hyperbolic Planes*, 85.

⁴² *Ibid.*, 119-131.

⁴³ "Paper Hyperbolic Plane Models"

Bibliography

- Boyer, Carl B. *A History of Mathematics*. Revised by Uta C. Merzbach. New York: John Wiley and Sons, Inc., 1991.
- Camenga, Kristin. "Paper Hyperbolic Plane Models." *Association of Mathematics Teachers of New York State*, 2006.
- Cannon, James W., Floyd, William J., Kenyon, Richard, and Parry, Walter R. "Hyperbolic Geometry." In *Flavors of Geometry* Volume 31, 1997.
- Greenberg, Marvin Jay. *Euclidean and Non-Euclidean Geometries*. New York: W.H. Freeman and Company, 1993.
- Henderson, David, Taimina, Daina, Wertheim, Margaret. "Crocheting the Hyperbolic Plane: An Interview with David Henderson and Daina Taimina." In *Cabinet Magazine* Volume 16, 2005.
- Henderson, David and Taimina, Daina. "Crocheting the Hyperbolic Plane." In *Mathematical Intelligencer* Volume 23, 2001: 17-28.
- Kalajdzievski, Sasho. *Math and Art: An Introduction to Visual Mathematics*. New York: CRC Press, 2008.
- Martin, George E. *The Foundations of Geometry and the Non-Euclidean Plane*. New York: Intext Educational Publishers, 1975.
- Robles, Colleen. "The Hyperbolic Geometry Exhibit." Last modified July 15, 1996. <http://www.geom.uiuc.edu/~crobles/hyperbolic/hypr/modl/>.
- Royster, David C. "Neutral and Non-Euclidean Geometries." Last modified October 21, 1996. <http://math.uncc.edu/~droyster/math3181/notes/hyprgeom/node58.html#SECTION00203000000000000000>.

Sved, Martha. *Journey into Geometries*. Washington, DC: Mathematical Association of America, 1991.

Taimina, Daina. *Crocheting Adventures with Hyperbolic Planes*. Natick, MA: A K Peters, Ltd., 2006.